

"Would You Want to Be A Victorian Miner? (D&T)"

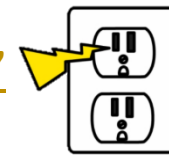

Important People

Sir Humphry Davy

(1778 – 1829)

Invented the safety lamp for use in coal mines to reduce the risk of explosions.







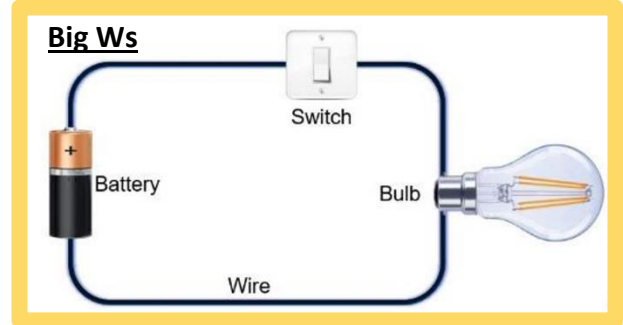
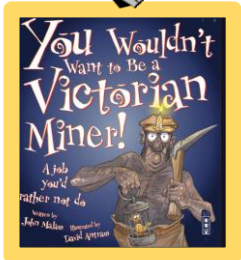

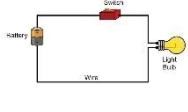

Big Ws

input	output
	

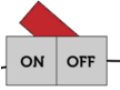

Vocabulary

battery	bulb	circuit	components	flame resistant	flaw	switch	wire
							
Used for generating current and power.	Glass part of an electric lamp which gives out light.	A complete and closed path around which electricity can flow.	One of the parts of a circuit.	Something that does not catch fire.	Something that needs improving.	Something that makes a component turn on and off.	A long thin piece of metal covered in plastic.